



AIR CONTROL
MODEL 0160
FIRE DAMPER

INSTALLATION, OPERATION
AND MAINTENANCE MANUAL

Index

	Page
Introduction and Health & Safety	3
Fire damper – Model 0160	
Two hour flexible wall – AFS with drop rods one side	4
Two hour flexible wall – AFS with drop rods in wall	5
Two hour flexible wall – multi-section AFS with drop rods two sides	6
Two hour rigid wall – AFS with drop rods one side	7
Two hour rigid wall – HEVAC	8
Two hour flexible wall – drywall plate with cleats	9
Two hour rigid floor – AFS	10
Two hour rigid floor – HEVAC	11
Operation and Maintenance	12
DW145 Fire Damper Certificate	13



Introduction

Advanced Air (UK) Ltd have been manufacturing a comprehensive range of fire dampers and fire smoke dampers since 1975. We have always taken pride in our products and tested to the highest standards, originally to BS476 and now more stringent testing to CE labelling under the Construction Product Regulation which was introduced 1st July 2013.

All our fire, fire smoke and smoke control dampers have been tested to BS EN 1366-2 and BS EN 1366-10. This is to cover a variety of installations used on sites today. Under CE labelling all dampers must follow the Product Standards BS EN 15650 and BS EN 12101-8 which ensures the product is consistent and supplied to the same specification and standard as tested. Any deviation or changes from the installations in this manual would require the dampers to be subject to a new test or approval sought from Local Building Control.

In line with product standards we are pleased to offer this installation manual covering installation, operation and maintenance instructions together with Health and Safety information. We have also included within this manual an example of the Fire Damper Certificate DW145 Inspection and Handover Check Sheet which is to be completed by the installer. A separate certificate is required per damper.

The installation contained in this manual cover most installation on site. However, there are still installation which Advanced Air (UK) Ltd have not yet tested. We are continually reviewing requirements and continuously developing the products. As additional installation tests are carried out and classified, installations will be added to this manual, and the Declaration of Performance (DoP) updated accordingly.

Health and Safety

Any instruction contained within this manual must be undertaken by competent trained personnel. When completing the installation standard PPE should be used, steel toe cap boots, hard hat, gloves, protective eyewear along with any other specific site or material instructions.

The size and weight of dampers vary, and it may require two or more persons to safely handle and move them. Do not lift the dampers by the blades or the actuator.

For the installation of dampers at high level, the correct lifting equipment shall be used in accordance with the Work at Height Regulations 2005 and specific site rules.

All waste materials should be collected and disposed of defined by the suppliers.

FIRE – 0160 ADJUSTABLE FRAME SYSTEM FOR TWO HOUR FLEXIBLE SUPPORTING CONSTRUCTION (SUPPORT ONE SIDE)

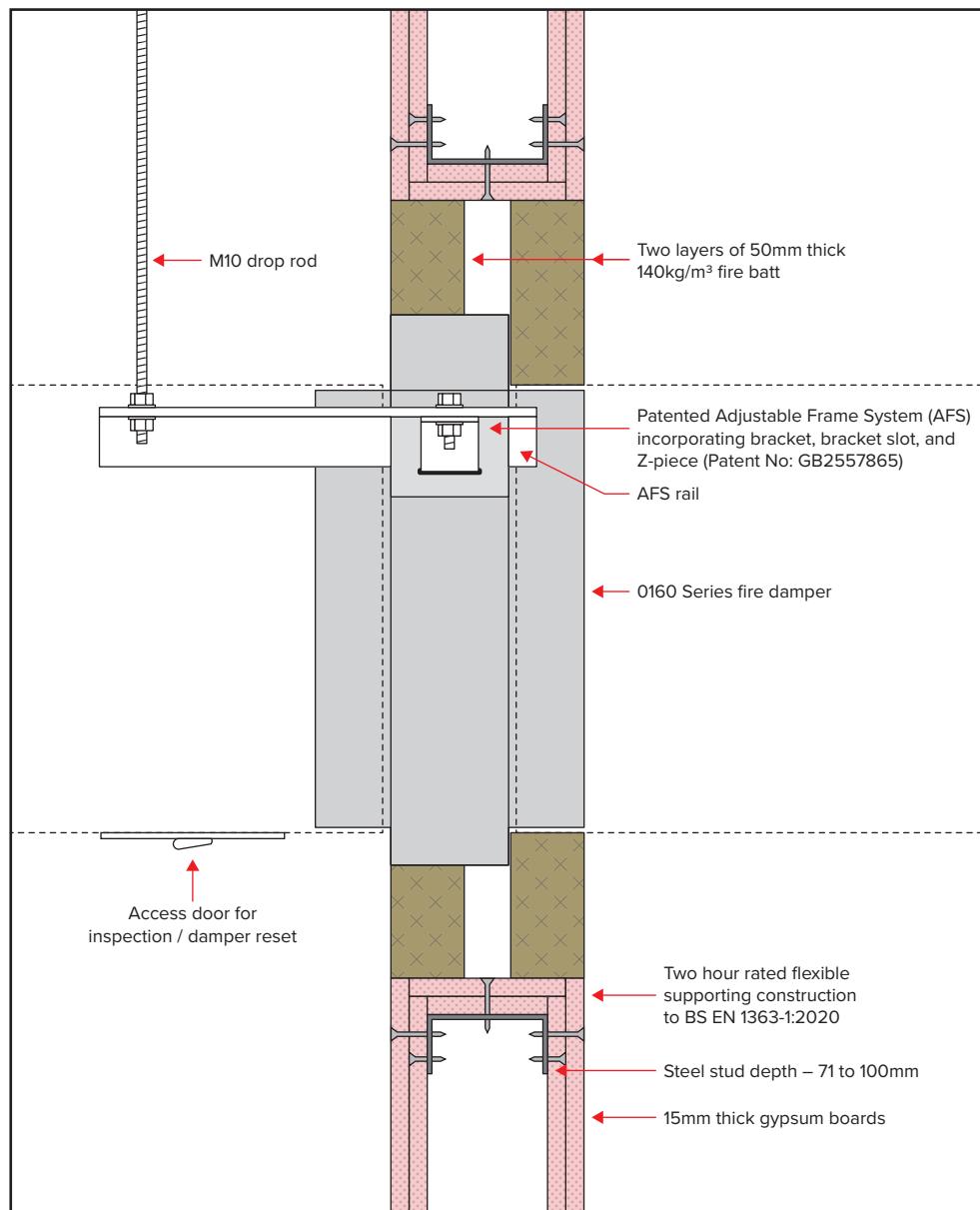

Preparation

- 1 Ensure that the damper is kept in a clean dry environment and that there is no damage to the damper.
- 2 Remove all the packaging and transit ties before installation.
- 3 Work out the opening size to be cut using the adjacent table.

Nom. duct width	Opening width min.	Opening width max.
100-1,000mm	Nom. duct +194mm	Nom. duct +350mm
Nom. duct height	Opening height min.	Opening height max.
100mm	Nom. duct +100mm	Nom. duct +350mm
101-300mm	Nom. duct +125mm	Nom. duct +375mm
301-525mm	Nom. duct +150mm	Nom. duct +400mm
526-700mm	Nom. duct +175mm	Nom. duct +425mm
701-925mm	Nom. duct +200mm	Nom. duct +450mm
926-1,000mm	Nom. duct +225mm	Nom. duct +475mm

Installation sequence

- 4 The drywall will consist of two layers of 15mm plasterboard each side of steel studwork with an optional mineral wool insulation. The opening will be a letterbox construction with overlapping layers of plasterboard with an opening clearance around the damper casing in line with the above table.
- 5 Two M10 drop rods per fire damper shall be fitted on one side of the drywall. These should be securely installed in line with the manufacturer's fixing instructions in a position to match the AFS rail.
- 6 The drop rods should have a nut screwed on for clamping the rail from above.
- 7 Slide the AFS rails on each side of the damper into the brackets and insert the "Z" piece into the bracket slot pushing it up against the underside of the rail. Insert the 8mm bolt from above into the slot through the "Z" piece fitting the nut until tight to secure the rail.
- 8 The damper should be mounted centrally in the opening flush with the wall on the side with the drop rods, as detailed in the drawing. The drop rods are to slide through the slots in the rail and a nut screwed on to take the support of the damper rail. The damper must then be levelled and when in the correct position the nut above the rail should be tightened against the rail.
- 9 The galvanised mild steel ductwork connecting to the damper spigots must overlap by up to 40mm, leaving a minimum 10mm clearance for any duct expansion in a fire situation.
- 10 The galvanised mild steel ductwork connections must be sealed with an approved galvanised mild steel ductwork sealer and fixed with low resistance fixings such as aluminium rivets that will melt at high temperature allowing the duct to break away without effecting the integrity of the installation.
- 11 The connecting galvanised mild steel ductwork must be independently supported within one metre of the connections and have been installed in accordance with DW144.
- 12 The gap between the damper and the wall opening will need filling with two layers of 50mm thick 140kg/m³ fire batt cut to an interference fit and pushed in to place. All cut edges must be sealed with a firebatt sealant to BS EN 13501-2. A fire rated intumescent mastic to BS EN 13501-2 shall be applied to each joint.
- 13 An access door should be fitted on the access side of the damper to enable the resetting of the damper blades.
- 14 When the damper installation has been completed checks should be made to ensure the AFS rails are secure and there is no movement, operation of the damper should be checked.
- 15 Complete DW145 Fire Damper Certificate.

PRODUCT **0160 W/ AFS RAIL**

APPLICATION **FLEXIBLE SUPPORTING CONSTRUCTION**

CLASSIFICATION REPORT NO. **TBA**

CLASSIFICATION **E120 (VE I ↔ O)**

TESTED INSTALLATION METHOD SHOWN. DIFFERING INSTALLATION METHODS TO THIS MUST BE APPROVED BY THE BUILDING CONTROL AUTHORITY (BCA) BEFORE PROCEEDING.

FIRE – 0160 ADJUSTABLE FRAME SYSTEM (IN WALL) FOR TWO HOUR FLEXIBLE SUPPORTING CONSTRUCTION

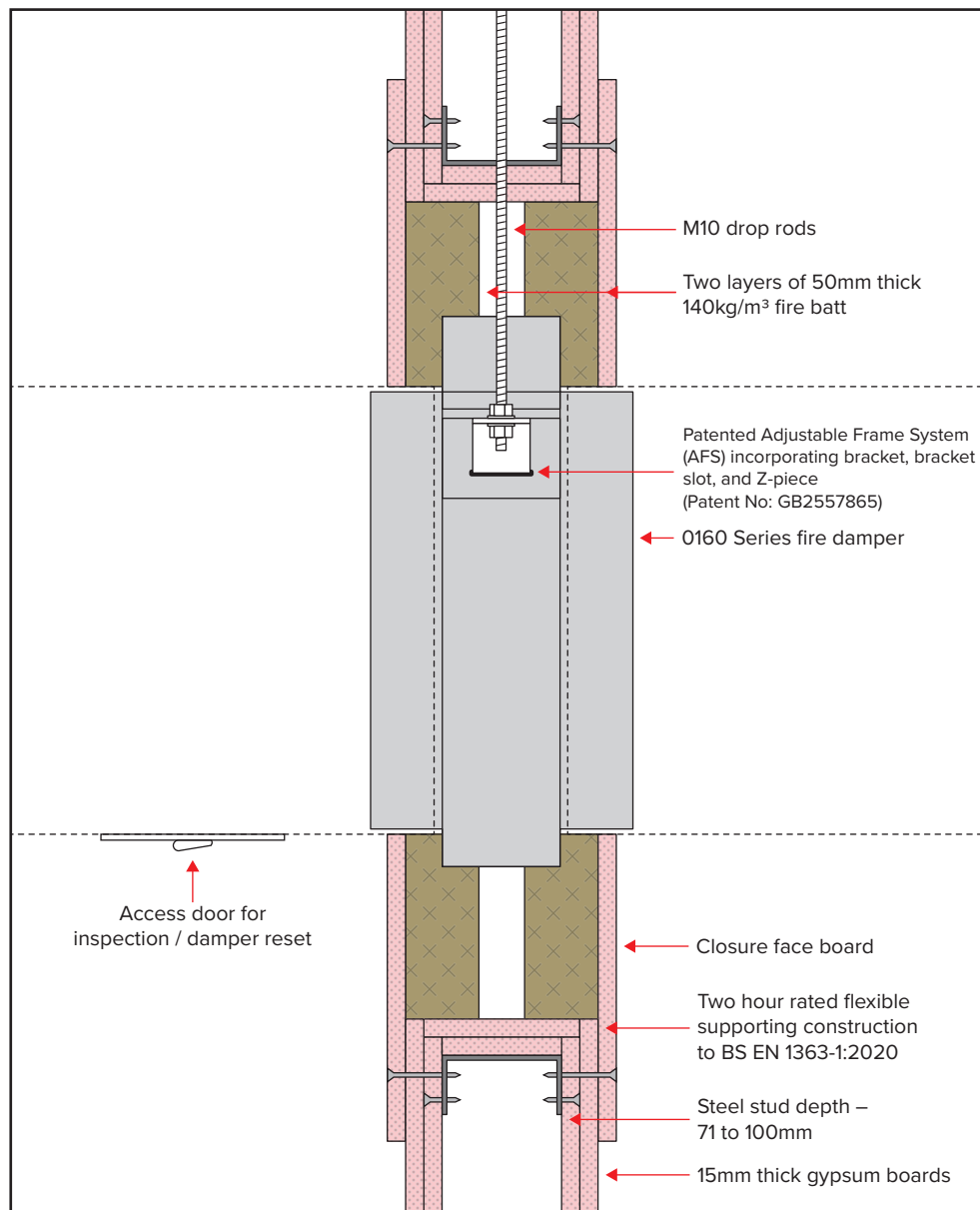

Preparation

- 1 Ensure that the damper is kept in a clean dry environment and that there is no damage to the damper.
- 2 Remove all the packaging and transit ties before installation.
- 3 Work out the opening size to be cut using the adjacent table.

Nom. duct width	Opening width min.	Opening width max.
100-1,000mm	Nom. duct +194mm	Nom. duct +350mm
Nom. duct height	Opening height min.	Opening height max.
100mm	Nom. duct +100mm	Nom. duct +350mm
101-300mm	Nom. duct +125mm	Nom. duct +375mm
301-525mm	Nom. duct +150mm	Nom. duct +400mm
526-700mm	Nom. duct +175mm	Nom. duct +425mm
701-925mm	Nom. duct +200mm	Nom. duct +450mm
926-1,000mm	Nom. duct +225mm	Nom. duct +475mm

Installation sequence

- 4 The drywall will consist of two layers of 15mm plasterboard each side of steel studwork with an optional mineral wool insulation. The opening will be a letterbox construction with overlapping layers of plasterboard with an opening clearance around the damper casing in line with the above table.
- 5 Two M10 drop rods per fire damper shall be fitted centrally within the flexible wall fixed by steel anchors into the slab or soffit above. These should be securely installed in line with the manufacturer's fixing instructions in a position to match the AFS rail.
- 6 The drop rods should have a nut screwed on for clamping the rail from above.
- 7 Slide the AFS rails on each side of the damper into the brackets and insert the "Z" piece into the bracket slot pushing it up against the underside of the rail. Insert the 8mm bolt from above into the slot through the "Z" piece fitting the nut until tight to secure the rail.
- 8 The damper should be mounted centrally in the opening as detailed in the drawing. The drop rods are to slide through the slots in the rail and a nut screwed on to take the support of the damper rail. The damper must then be levelled and when in the correct position the nut above the rail should be tightened against the rail.
- 9 The galvanised mild steel ductwork connecting to the damper spigots must overlap by up to 40mm, leaving a minimum 10mm clearance for any duct expansion in a fire situation.
- 10 The galvanised mild steel ductwork connections must be sealed with an approved galvanised mild steel ductwork sealer and fixed with low resistance fixings such as aluminium rivets that will melt at high temperature allowing the duct to break away without effecting the integrity of the installation.
- 11 The connecting galvanised mild steel ductwork must be independently supported within one metre of the connections and have been installed in accordance with DW144.
- 12 The gap between the damper and the wall opening will need filling with two layers of 50mm thick 140kg/m³ fire batt cut to an interference fit and pushed in to place. All cut edges must be sealed with a firebatt sealant to BS EN 13501-2. A fire rated intumescent mastic to BS EN 13501-2 shall be applied to each joint.
- 13 A closure face board of 15mm plasterboard is screwed to each side of the wall. It must fully cover the fire batt and overlap the opening by 50mm.
- 14 An access door should be fitted on the access side of the damper to enable the resetting of the damper blades.
- 15 When the damper installation has been completed checks should be made to ensure the drop rods are secured to the cleats and there is no movement, operation of the damper should be checked.
- 16 Complete DW145 Fire Damper Certificate.

PRODUCT **0160 W/ AFS RAIL**

APPLICATION **FLEXIBLE SUPPORTING CONSTRUCTION, SUPPORT IN WALL**

CLASSIFICATION REPORT NO. **BRE 287811C**

CLASSIFICATION **E120 (VE I ↔ O)**

TESTED INSTALLATION METHOD SHOWN. DIFFERING INSTALLATION METHODS TO THIS MUST BE APPROVED BY THE BUILDING CONTROL AUTHORITY (BCA) BEFORE PROCEEDING.

FIRE – 0160 MULTI-SECTION ADJUSTABLE FRAME SYSTEM FOR FLEXIBLE SUPPORTING CONSTRUCTION

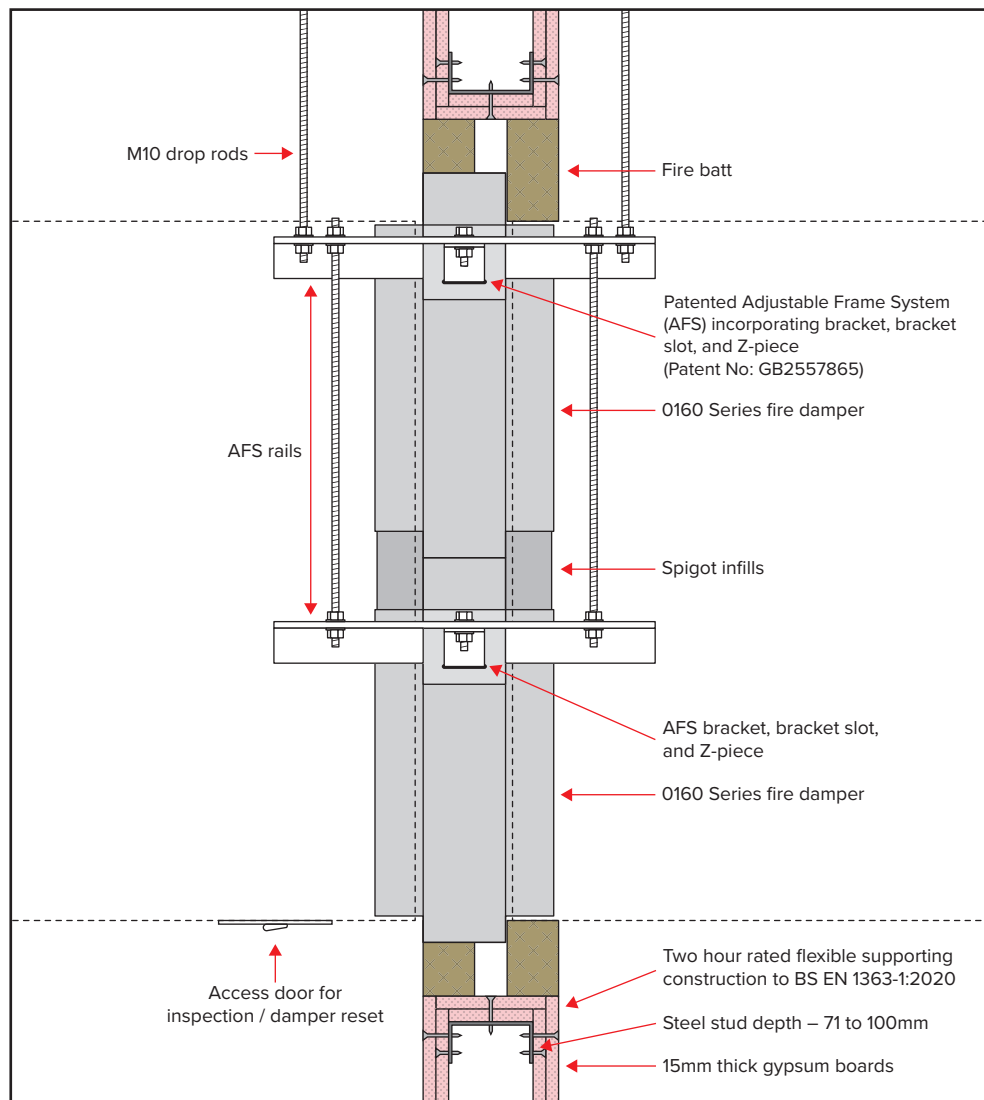

While we have tested a damper 2,000 x 2,000mm, larger sizes can be supplied but the installation will need to be checked by a competent structural engineer as stated in the Extended Fields of Application BS EN 15882-2:2015. With all larger sizes there should be a risk assessment carried out and a full method statement documented to ensure the correct lifting gear and safety precautions are put in place prior to the installation being carried out.

Preparation

- 1 Ensure that the damper is kept in a clean dry environment and that there is no damage to the damper.
- 2 Remove all the packaging and transit ties before installation.
- 3 Work out the opening size to be cut using the adjacent table.

Nom. duct width	Opening width min.	Opening width max.
1001-2,000mm	Nom. duct +194mm	Nom. duct +350mm
Nom. duct height	Opening height min.	Opening height max.
1001-1146mm	Nom. duct +150mm	Nom. duct +400mm
1147-1521mm	Nom. duct +175mm	Nom. duct +425mm
1552-1996mm	Nom. duct +200mm	Nom. duct +450mm
1997-2000mm	Nom. duct +225mm	Nom. duct +475mm

Installation sequence

- 4 The drywall will consist of two layers of 15mm plasterboard each side of steel studwork with an optional mineral wool insulation. The opening will be a letterbox construction with overlapping layers of plasterboard with an opening clearance around the damper casing in line with the above table.
- 5 Two M10 drop rods per fire damper shall be fitted on both sides of the drywall. These should be securely installed in line with the manufacturer's fixing instructions in a position to match the AFS rail.
- 6 The drop rods should have a nut screwed on for clamping the rail from above. These rods will be secured to the two top AFS rails.
- 7 Slide the AFS rails in all the brackets and insert the "Z" piece into the bracket slot pushing it up against the underside of the rail. Insert the 8mm bolt from above into the slot through the "Z" piece fitting the nut until tight to secure the rail.
- 8 Additional drop rods should then be passed through the top and bottom rails and fully tightened.
- 9 The damper should be mounted centrally in the opening flush with the wall on one side. The anchored drop rods are to slide through the top rails and nuts are screwed on to take the support. The damper must then be levelled and when in the correct position the nut above the rail should be tightened against the rail.
- 10 The galvanised mild steel ductwork connecting to the damper spigots must overlap by up to 40mm, leaving a minimum 10mm clearance for any duct expansion in a fire situation.
- 11 The galvanised mild steel ductwork connections must be sealed with an approved galvanised mild steel ductwork sealer and fixed with low resistance fixings such as aluminium rivets that will melt at high temperature allowing the duct to break away without effecting the integrity of the installation.
- 12 The connecting galvanised mild steel ductwork must be independently supported within one metre of the connections and have been installed in accordance with DW144.
- 13 The gap between the damper and the wall opening will need filling with two layers of 50mm thick 140kg/m³ fire batt cut to an interference fit and pushed in to place. All cut edges must be sealed with a firebatt sealant to BS EN 13501-2. A fire rated intumescent mastic (to BS EN 13501-2) shall be applied to each joint.
- 14 An access door should be fitted on the access side of the damper to enable the resetting of the damper blades.
- 15 When the damper installation has been completed checks should be made to ensure the AFS rails are secured to the damper and there is no movement, operation of the damper should be checked.
- 16 Complete DW145 Fire Damper Certificate.

PRODUCT 0160 MULTISECTION W/AFS	APPLICATION FLEXIBLE SUPPORTING CONSTRUCTION
CLASSIFICATION REPORT NO. TBA	CLASSIFICATION E120 (VE I ↔ O)
TESTED INSTALLATION METHOD SHOWN. DIFFERING INSTALLATION METHODS TO THIS MUST BE APPROVED BY THE BUILDING CONTROL AUTHORITY (BCA) BEFORE PROCEEDING.	

FIRE – 0160 ADJUSTABLE FRAME SYSTEM FOR TWO HOUR RIGID SUPPORTING CONSTRUCTION

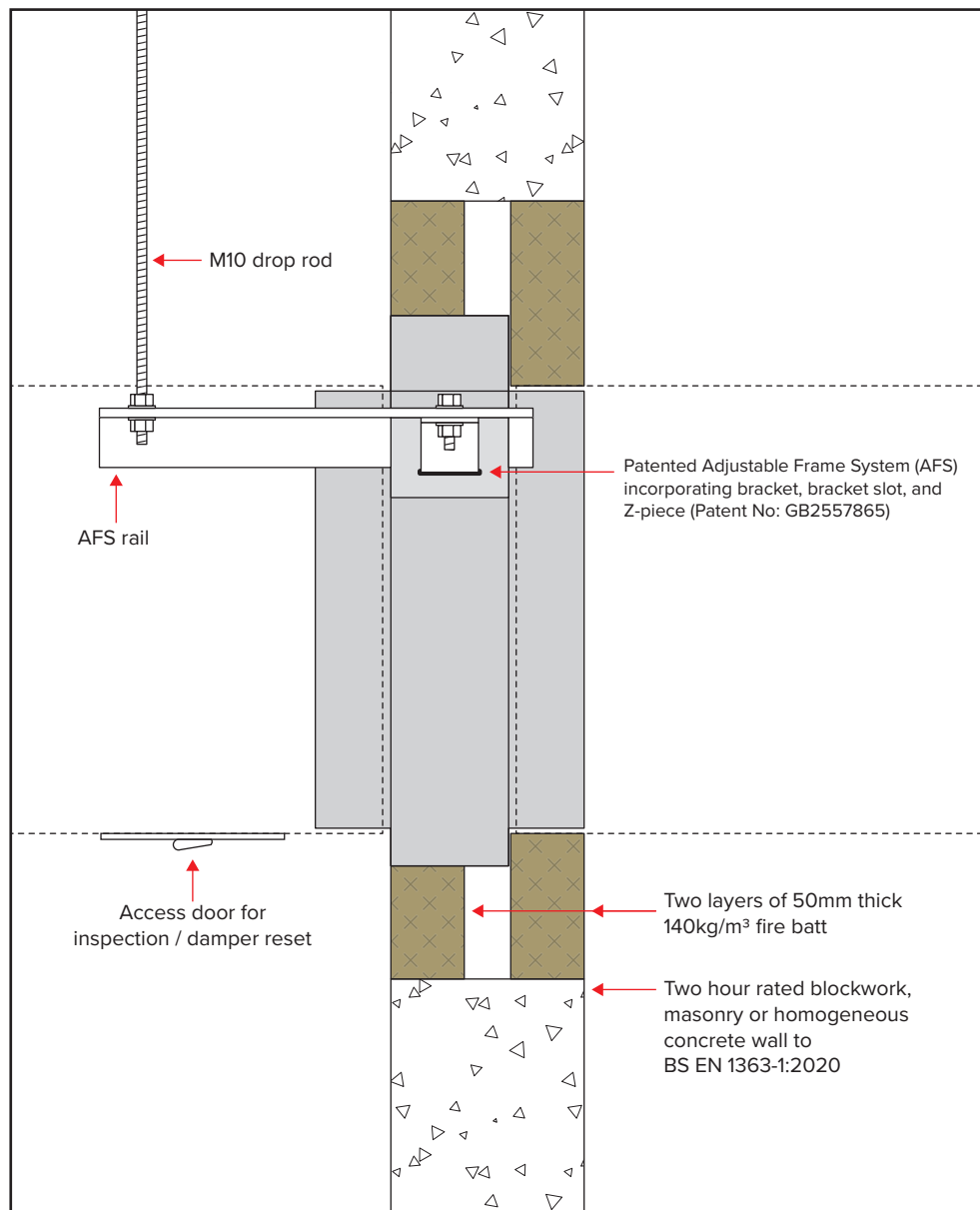

Preparation

- 1 Ensure that the damper is kept in a clean dry environment and that there is no damage to the damper.
- 2 Remove all the packaging before installation.
- 3 Work out the opening size to be cut using the adjacent table.

Nom. duct width	Opening width min.	Opening width max.
100-1,000mm	Nom. duct +194mm	Nom. duct +350mm
Nom. duct height	Opening height min.	Opening height max.
100mm	Nom. duct +100mm	Nom. duct +350mm
101-300mm	Nom. duct +125mm	Nom. duct +375mm
301-525mm	Nom. duct +150mm	Nom. duct +400mm
526-700mm	Nom. duct +175mm	Nom. duct +425mm
701-925mm	Nom. duct +200mm	Nom. duct +450mm
926-1,000mm	Nom. duct +225mm	Nom. duct +475mm

Installation sequence

- 4 Two M10 drop rods shall be fitted on one side of the drywall.
- 5 The drop rods should have a nut screwed on for clamping the rail from above.
- 6 Slide the AFS rails on each side of the damper into the brackets and insert the "Z" piece into the bracket slot pushing it up against the underside of the rail. Insert the 8mm bolt from above into the slot through the "Z" piece fitting the nut until tight to secure the rail.
- 7 The damper should be centrally positioned in the opening with the access side flush with the wall, as detailed in the drawing. The drop rods are to slide through the slots in the rail and a nut screwed on to take the support of the damper rail. The damper must then be levelled and when in the correct position the nut above the rail should be tightened against the rail.
- 8 The galvanised mild steel ductwork connecting to the damper spigots must overlap by up to 40mm, leaving a minimum 10mm clearance for any duct expansion in a fire situation.
- 9 The galvanised mild steel ductwork connections must be sealed with an approved galvanised mild steel ductwork sealer and fixed with low resistance fixings such as aluminium rivets that will melt at high temperature allowing the duct to break away without affecting the integrity of the installation.
- 10 The connecting galvanised mild steel ductwork must be independently supported within one metre of the connections and have been installed in accordance with DW144.
- 11 The gap between the damper and the wall opening will need filling with two layers of 50mm thick 140kg/m³ fire batt cut to an interference fit and pushed in to place. A fire rated mastic will be applied to each joint.
- 12 An access door should be fitted on the access side of the damper to enable the resetting of the damper blades.
- 13 When the damper installation has been completed checks should be made to ensure the AFS rails are secure and there is no movement, operation of the damper should be checked.
- 14 Complete DW145 Fire Damper Certificate.

PRODUCT **0160 W/ AFS RAIL**

APPLICATION **RIGID CONSTRUCTION**

CLASSIFICATION REPORT NO. **TBA**

CLASSIFICATION **E120 (VE I ↔ O)**

TESTED INSTALLATION METHOD SHOWN. DIFFERING INSTALLATION METHODS TO THIS MUST BE APPROVED BY THE BUILDING CONTROL AUTHORITY (BCA) BEFORE PROCEEDING.

FIRE – 0160 HEVAC FOR RIGID SUPPORTING CONSTRUCTION (WALL)

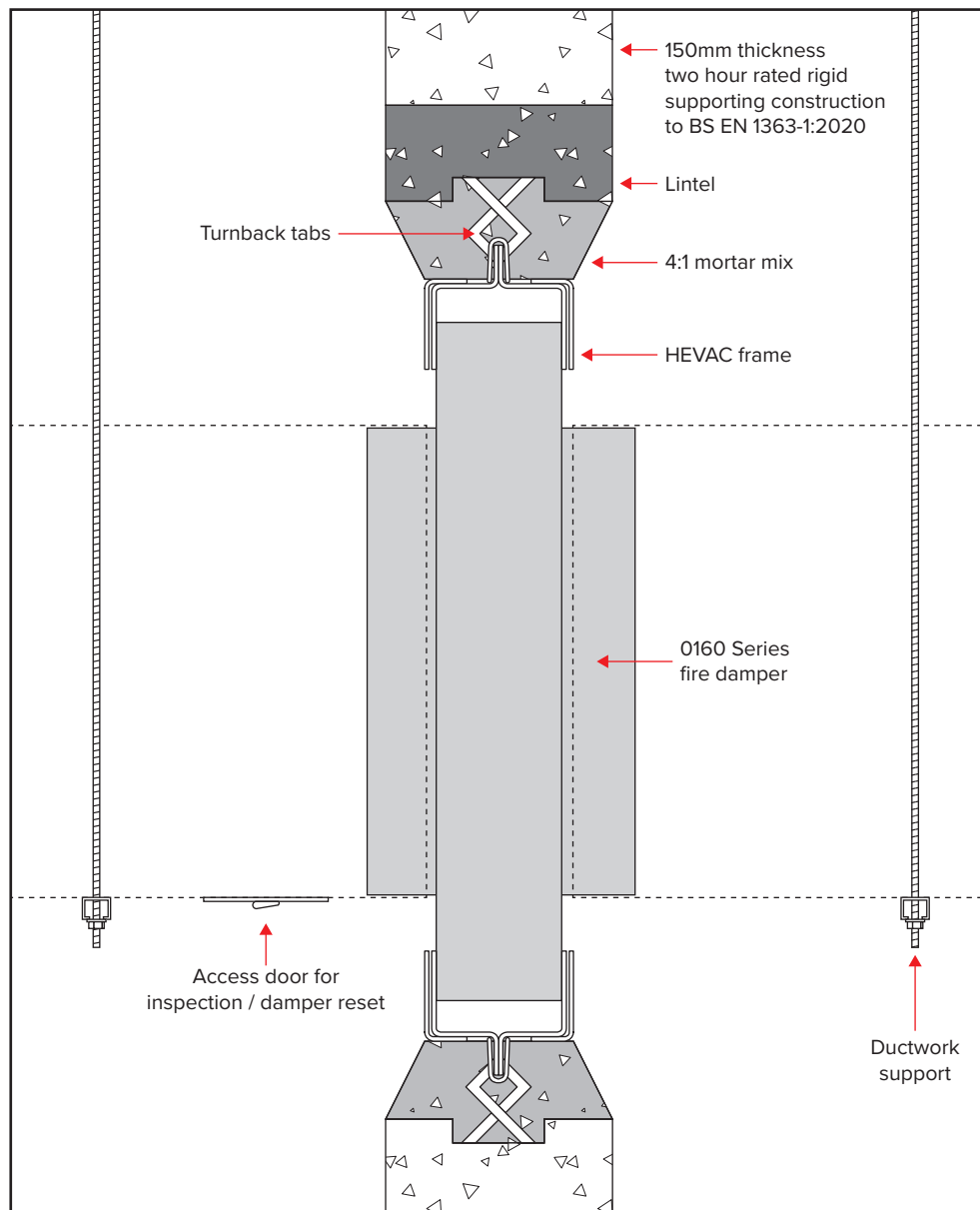

Preparation

- 1 Ensure that the damper is kept in a clean dry environment and that there is no damage to the damper.
- 2 Remove all the packaging and transit ties before installation.
- 3 Work out the opening size to be cut using the adjacent table.

Nom. duct width	Opening width min.	Opening width max.
100-1,000mm	Nom. duct +160mm	Nom. duct +185mm
Nom. duct height	Opening height min.	Opening height max.
100mm	Nom. duct +160mm	Nom. duct +185mm
101-300mm	Nom. duct +185mm	Nom. duct +210mm
301-525mm	Nom. duct +210mm	Nom. duct +235mm
526-700mm	Nom. duct +235mm	Nom. duct +260mm
701-925mm	Nom. duct +260mm	Nom. duct +285mm
926-1,000mm	Nom. duct +285mm	Nom. duct +310mm

Installation sequence

- 4 In the opening, mark the positions for the turnback ties on the HEVAC frame.
- 5 Create 20mm deep pockets for the HEVAC tabs to be located in.
- 6 Offer up the damper into the opening and support from the bottom of the damper so that it sits centrally within the opening and has an even space on all four sides.
- 7 Bend the HEVAC tabs so that they lock into the pockets.
- 8 A 4:1 mortar mix can then be gradually applied between the wall and the damper, ensuring the mortar is only filled up to the HEVAC frame and not the damper spigots. This ensures the damper can move within the HEVAC frame.
- 9 The galvanised mild steel ductwork connecting to the damper spigots must overlap by up to 40mm, leaving minimum 10mm clearance for any duct expansion in a fire situation.
- 10 The galvanised mild steel ductwork connections must be sealed with an approved galvanised mild steel ductwork sealer and fixed with low resistance fixings such as aluminium rivets that will melt at high temperature allowing the duct to break away with affecting the integrity of the installation.
- 11 The connecting galvanised mild steel ductwork must be independently supported within one metre of the connections and have been installed in accordance with DW144.
- 12 An access door should be fitted on the access side of the damper to enable the resting of the damper blades.
- 13 When the damper installation has been completed, checks should be made to ensure the damper is secure and there is no movement, operation of the damper should be checked.
- 14 Complete DW145 Fire Damper Certificate.

PRODUCT **0160 W/ HEVAC FRAME**

APPLICATION **RIGID SUPPORTING CONSTRUCTION**

CLASSIFICATION REPORT NO. **BRE 262247B**

CLASSIFICATION **E120 (VE I ↔ O)**

TESTED INSTALLATION METHOD SHOWN. DIFFERING INSTALLATION METHODS TO THIS MUST BE APPROVED BY THE BUILDING CONTROL AUTHORITY (BCA) BEFORE PROCEEDING.

FIRE – 0160 DRYWALL PLATE INSTALLATION FOR FLEXIBLE SUPPORTING CONSTRUCTION

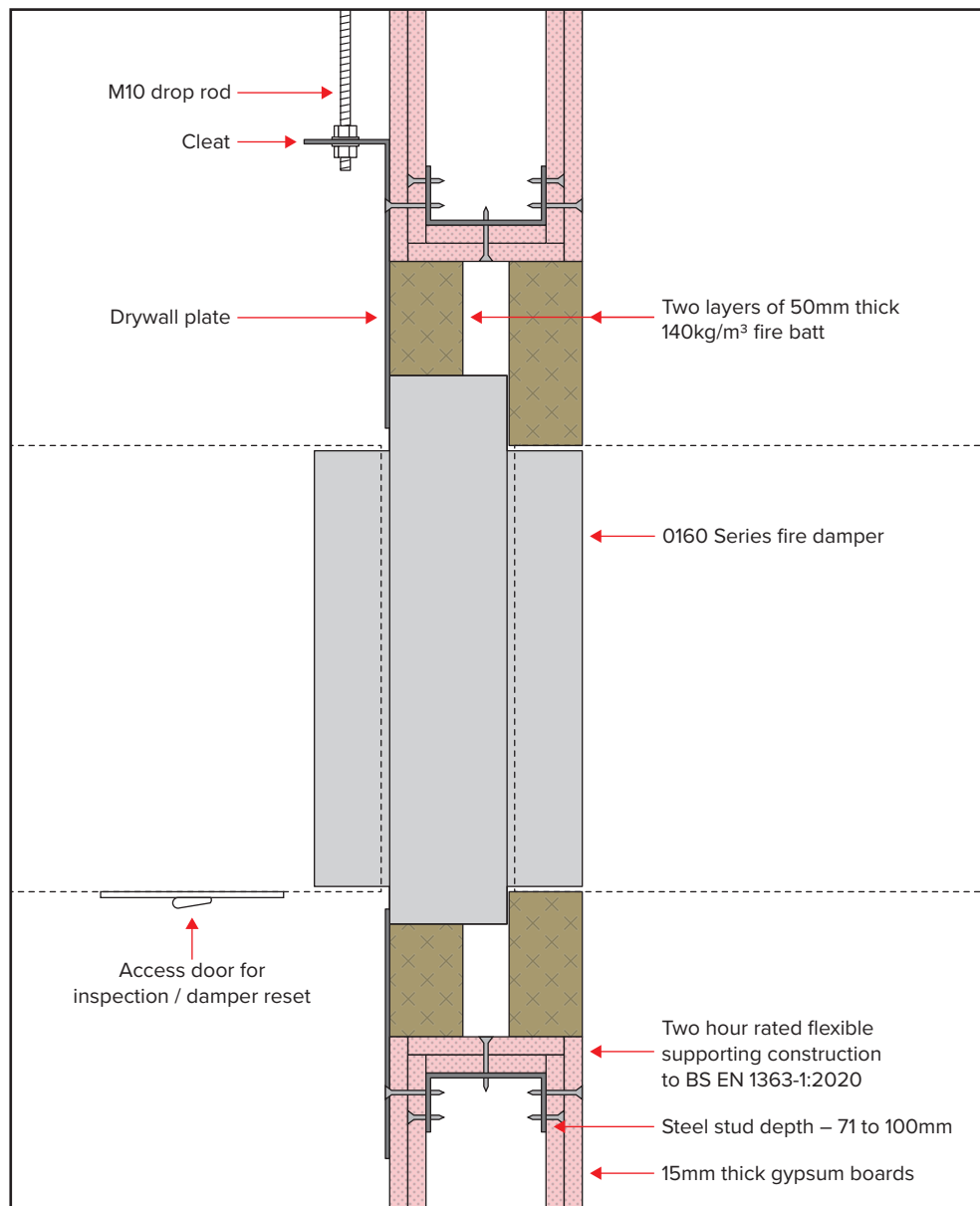

Preparation

- 1 Ensure that the damper is kept in a clean dry environment and that there is no damage to the damper.
- 2 Remove all the packaging and transit ties before installation.
- 3 Work out the opening size to be cut using the adjacent table.

Nominal duct width	Opening width maximum
100-1,000mm	Nominal duct +90mm
Nominal duct height	Opening height maximum
100mm	Nominal duct +90mm
101-300mm	Nominal duct +115mm
301-525mm	Nominal duct +140mm
526-700mm	Nominal duct +165mm
701-925mm	Nominal duct +190mm
926-1,000mm	Nominal duct +215mm

Installation sequence

- 4 The drywall will consist of two layers of 15mm plasterboard each side of steel studwork with an optional mineral wool insulation. The opening will be a letterbox construction with overlapping layers of plasterboard with an opening clearance around the damper casing in line with the above table.
- 5 Two M10 drop rods per fire damper shall be fitted on one side of the drywall. These should be securely installed in line with the manufacturer's fixing instructions in a position to match the cleats on the dry wall damper frame.
- 6 The drop rods should have a nut screwed on for clamping the cleat from above.
- 7 The damper should be mounted centrally in the opening flush with the dry wall frame on the side with the drop rods, as detailed in the drawing. The drop rods are to slide through the holes in the cleats and a nut screwed on to take the support of the damper. The damper must then be levelled and when in the correct position the nut above the rail should be tightened against the cleat.
- 8 The galvanised mild steel ductwork connecting to the damper spigots must overlap by up to 40mm, leaving a minimum 10mm clearance for any duct expansion in a fire situation.
- 9 The galvanised mild steel ductwork connections must be sealed with an approved galvanised mild steel ductwork sealer and fixed with low resistance fixings such as aluminium rivets that will melt at high temperature allowing the duct to break away without effecting the integrity of the installation.
- 10 The connecting galvanised mild steel ductwork must be independently supported within one metre of the connections and have been installed in accordance with DW144.
- 11 The gap between the damper and the wall opening will need filling with two layers of 50mm thick 140kg/m³ fire batt cut to an interference fit and pushed in to place. All cut edges must be sealed with a firebatt sealant to BS EN 13501-2. A fire rated intumescent mastic (to BS EN 13501-2) shall be applied to each joint.
- 12 An access door should be fitted on the access side of the damper to enable the resetting of the damper blades.
- 13 When the damper installation has been completed checks should be made to ensure the drop rods are secured to the cleats and there is no movement, operation of the damper should be checked.
- 14 Complete DW145 Fire Damper Certificate.

PRODUCT **0160 W/ DRYWALL PLATE**

APPLICATION **FLEXIBLE SUPPORTING CONSTRUCTION**

CLASSIFICATION REPORT NO. **2019 EFFECTIS R002230**

CLASSIFICATION **E120 (VE I ↔ O)**

TESTED INSTALLATION METHOD SHOWN. DIFFERING INSTALLATION METHODS TO THIS MUST BE APPROVED BY THE BUILDING CONTROL AUTHORITY (BCA) BEFORE PROCEEDING.

FIRE – 0160 ADJUSTABLE FRAME SYSTEM FOR RIGID SUPPORTING CONSTRUCTION (FLOOR)

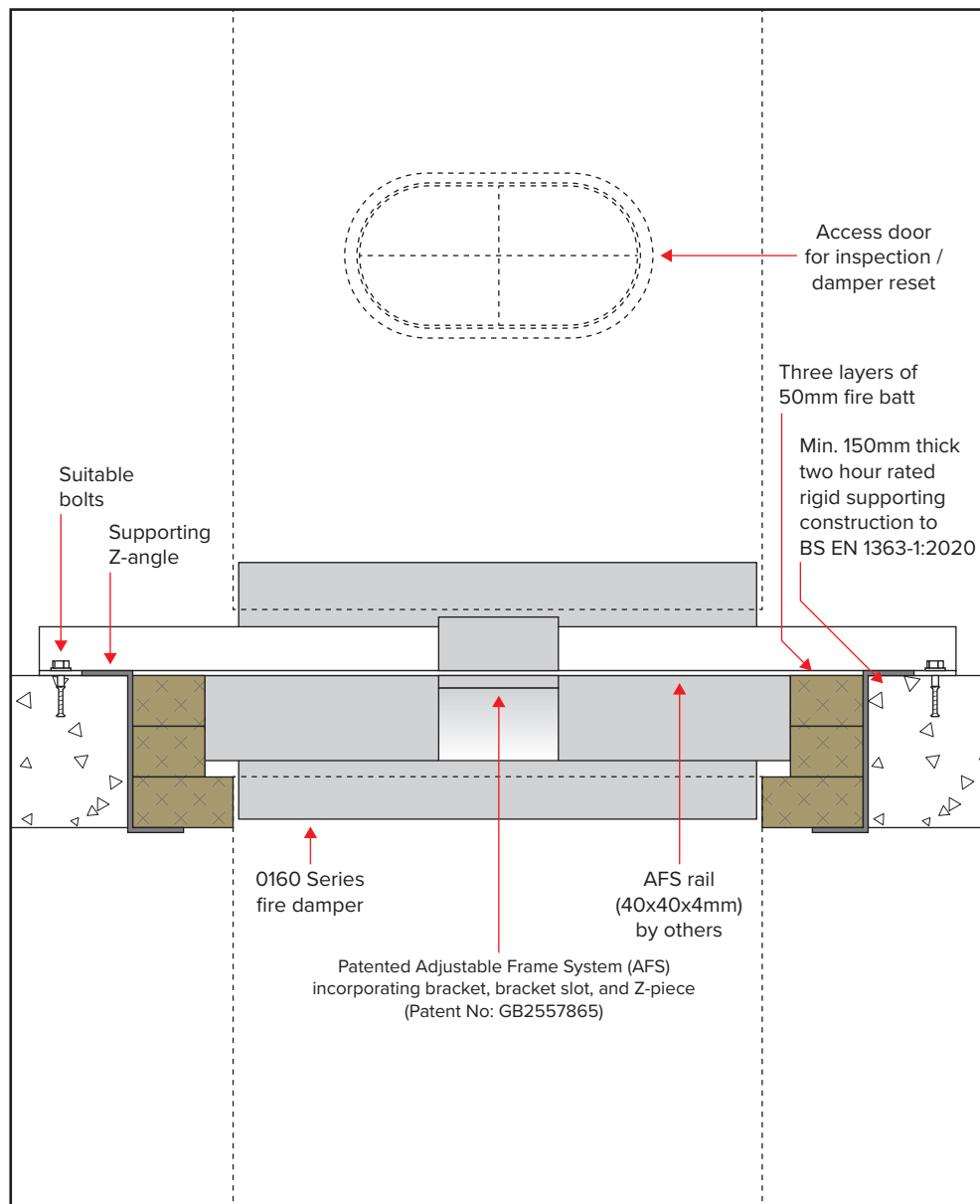

Preparation

- 1 Ensure that the damper is kept in a clean dry environment and that there is no damage to the damper.
- 2 Remove all the packaging and transit ties before installation.
- 3 Work out the opening size to be cut using the adjacent table.

Nom. duct width	Opening width min.	Opening width max.
100-1,000mm	Nom. duct +100mm	Nom. duct +350mm
Nom. duct height	Opening height min.	Opening height max.
100mm	Nom. duct +140mm	Nom. duct +350mm
101-300mm	Nom. duct +165mm	Nom. duct +375mm
301-525mm	Nom. duct +190mm	Nom. duct +400mm
526-700mm	Nom. duct +215mm	Nom. duct +425mm
701-925mm	Nom. duct +240mm	Nom. duct +450mm
926-1,000mm	Nom. duct +265mm	Nom. duct +475mm

Installation sequence

- 4 Install 40mm x 40mm x 4mm angle through the AFS brackets ensuring they are of sufficient length to extend past the opening on each side by 100mm.
- 5 Position the dampers evenly in the centre of the opening.
- 6 Secure the angles to the floor. Mark the hole positions on the angle at least 50mm away from the opening. Drill and install M8 steel anchors and bolt the angle to the floor.
- 7 The galvanised mild steel ductwork connecting to the damper spigot must overlap by 40mm, leaving a 10mm clearance for any duct expansion in a fire situation.
- 8 The galvanised mild steel ductwork connections must be sealed with an approved galvanised mild steel ductwork sealer and fixed with low resistance fixings such as aluminium rivets that will melt at high temperature allowing the duct to break away without affecting the integrity of the installation.
- 9 'Z' angles are required to support the first layer of fire batt. These measure 50mm x 150mm x 50mm by 100mm wide. They are to be positioned on all fire batt joints on the bottom layer and evenly spaced on a 500mm minimum pitch.
- 10 The gap between the damper and the floor opening will need filling with three layers of 50mm thick 140kg/m³ fire batt cut to an interference fit and pushed into place. All cut edges must be sealed with a fire batt sealant to BS EN 13501-2. A fire rated intumescent mastic to BS EN 13501-2 shall be applied to each joint.
- 11 The connecting galvanised mild steel ductwork must be independently supported within one metre of the connections and have been installed in accordance with DW144.
- 12 An access door should be fitted on the access side of the damper for inspection and maintenance.
- 13 When the damper installation is complete the operation of the damper should be checked.
- 14 Complete DW145 Fire Damper Certificate.

PRODUCT **0160 W/AFS**

APPLICATION **RIGID SUPPORTING CONSTRUCTION (FLOOR)**

CLASSIFICATION REPORT NO. **2013-EFFECTIS-RO511C**

CLASSIFICATION **E120 (HO I → O)**

TESTED INSTALLATION METHOD SHOWN. DIFFERING INSTALLATION METHODS TO THIS MUST BE APPROVED BY THE BUILDING CONTROL AUTHORITY (BCA) BEFORE PROCEEDING.

FIRE – 0160 HEVAC FOR RIGID SUPPORTING CONSTRUCTION (FLOOR)

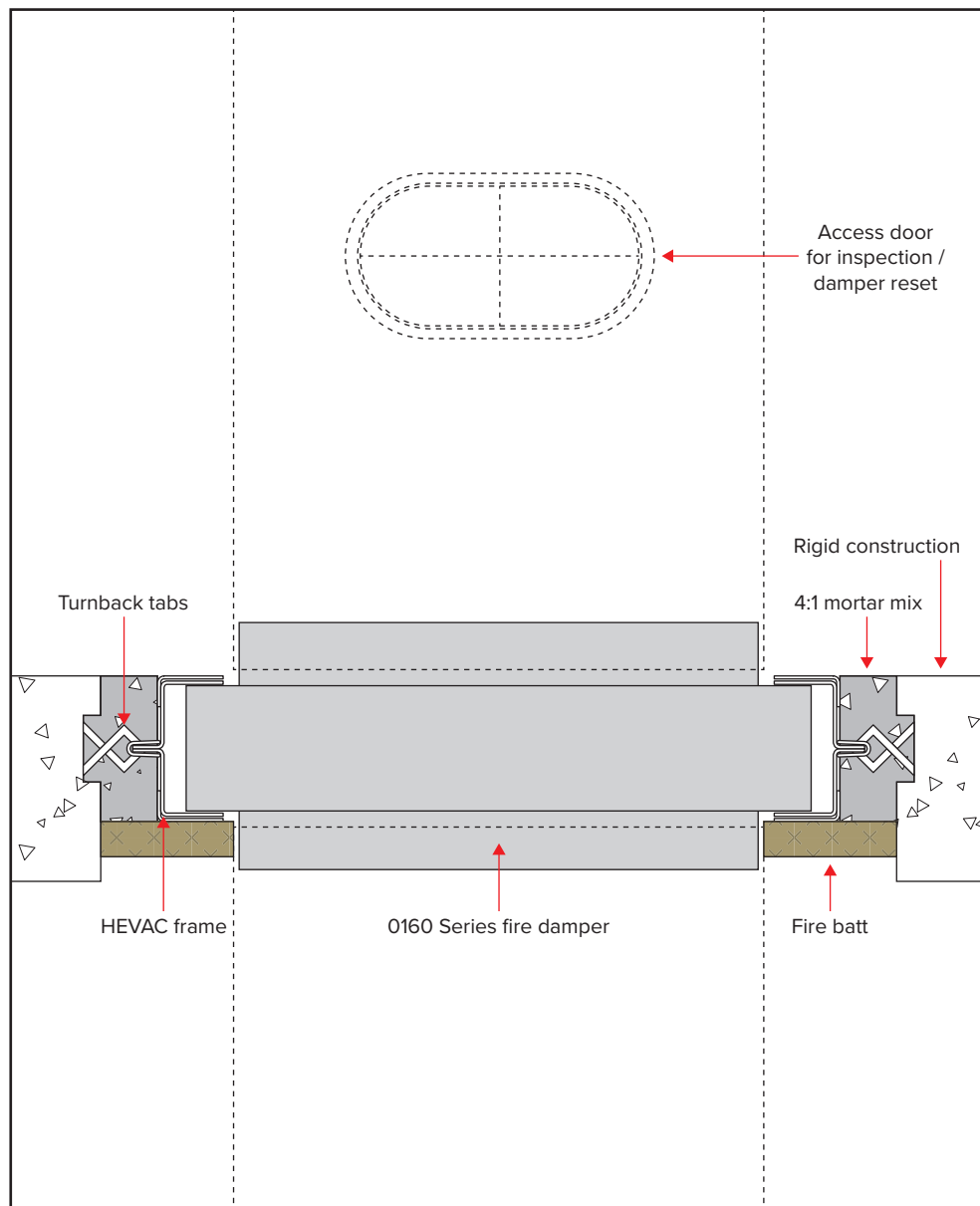

Preparation

- 1 Ensure that the damper is kept in a clean dry environment and that there is no damage to the damper.
- 2 Remove all the packaging and transit ties before installation.
- 3 Work out the opening size to be cut using the adjacent table.

Nom. duct width	Opening width min.	Opening width max.
100-1,000mm	Nom. duct +160mm	Nom. duct +185mm
Nom. duct height	Opening height min.	Opening height max.
100mm	Nom. duct +160mm	Nom. duct +185mm
101-300mm	Nom. duct +185mm	Nom. duct +210mm
301-525mm	Nom. duct +210mm	Nom. duct +235mm
526-700mm	Nom. duct +235mm	Nom. duct +260mm
701-925mm	Nom. duct +260mm	Nom. duct +285mm
926-1,000mm	Nom. duct +285mm	Nom. duct +310mm

Installation sequence

- 4 In the opening, mark the positions for the turnback tabs on the HEVAC frame, making sure that the HEVAC casing will sit flush with the floor surface.
- 5 Create 20mm deep pockets for the HEVAC tabs to be located in.
- 6 Offer up the damper into the opening and support from below or clamp angles spanning the opening.
- 7 Bend the HEVAC tabs so that they lock into the pockets.
- 8 Fire batt of a minimum 25mm thickness and density of 140kg/m² shall be installed under the damper frame to serve as shuttering to facilitate installation of the penetration seal all around the damper.
- 9 A 4:1 mortar mix can then be gradually applied between the floor and the damper, ensuring the mortar is only filled up to the HEVAC frame and not the damper spigots. This ensures the damper can move within the HEVAC frame.
- 10 The fire batt shall remain in situ after the mortar has been applied.
- 11 The galvanised mild steel ductwork connecting to the damper spigots must overlap by up to 40mm, leaving minimum 10mm clearance for any duct expansion in a fire situation.
- 12 The galvanised mild steel ductwork connections must be sealed with an approved galvanised mild steel ductwork sealer and fixed with low resistance fixings such as aluminium rivets that will melt at high temperature allowing the duct to break away without affecting the integrity of the installation.
- 13 The connecting galvanised mild steel ductwork must be independently supported within one metre of the connections and have been installed in accordance with DW144.
- 14 An access door should be fitted on the access side of the damper to enable the resetting of the damper blades.
- 15 When the damper installation has been completed, checks should be made to ensure the damper is secure and there is no movement, operation of the damper should be checked.
- 16 Complete DW145 Fire Damper Certificate.

PRODUCT **0160 W/HEVAC**

APPLICATION **RIGID CONSTRUCTION (FLOOR)**

CLASSIFICATION REPORT NO. **BRE 287811D**

CLASSIFICATION **E120 (HO I ↔ O)**

TESTED INSTALLATION METHOD SHOWN. DIFFERING INSTALLATION METHODS TO THIS MUST BE APPROVED BY THE BUILDING CONTROL AUTHORITY (BCA) BEFORE PROCEEDING.

0160 – OPERATION AND MAINTENANCE

Initial operating check

The 0160 fire damper should only be commissioned once installation has been completed.

The damper should be inspected thoroughly to ensure that it is clean and free of any internal debris before the damper is tested as per the following instructions;

- Remove the access door or doors, (on some installations access doors are required on both sides of the damper to enable the resetting of the damper). If a transportation tie is still fitted to the link, remove it.
- The 0160 fire damper is fitted with an EML fusible link, this link is provided with a release latch on the access side of the damper. To test the damper the latch is released allowing the blades to drop and the link is retained on a pivot opposite to the latch.
- Before testing the damper, check that the blade pack is sitting level to the drop direction, if they are sitting uneven before testing this could result in damage to the blades and spring system.
- Release the latch on the EML, the blades will drop quickly under the force of the springs and gravity, ensure that hands and arms are away from the direction of blade travel.



- Visually inspect the damper blades to ensure that they are all interlocked, that the springs are straight and that the bottom damper is locked into the locking ramp on both sides of the damper. NB;

- On vertically installed dampers 750 high and above, it is OK for these not to have springs and locking ramps fitted.

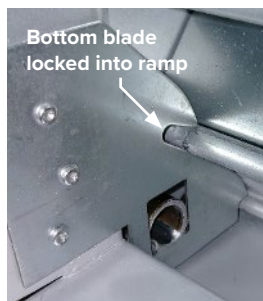

- To reset the damper, the bottom blade will need to be pushed away from the locking ramp, then keeping the bottom blade level push the blade pack upwards into the top of the damper. When the top has been reached the EML fusible link can then be swung into position and secured with the latch. NB;
 - For larger dampers independent supports may be required to hold the blade pack in position whilst securing the latch.
 - Dampers 149mm and under will have a ring pull fitted to enable the blade to be pulled away from the locking ramps, on these sizes the release latch is on the opposite side of the locking ramps. This is the reason access doors are required on both sides of the damper.
- Refit the access door and complete any relevant reports.

Maintenance

0160 fire dampers are installed as a life safety product and it is essential that they are always maintained so they are in a clean working condition. In accordance with BS9999 Annex W.1 maintenance and inspection should be undertaken annually.

Maintain the dampers as follows;

- Remove the access door to internally inspect the damper.
- Visually inspect all damper components for signs of corrosion, obstructions and build-up of dirt/dust.
- Remove any obstructions, wipe away all dirt and dust from the damper blades, sides and duct surfaces.
- Examine the EML fusible link to ensure that no corrosion has occurred.
- If the EML fusible link is required to be replaced, then should be done as follows:
 - Use independent supports or hold the damper blade pack in position.
 - Release the EML latch, the link will now drop and pivot on the opposite side.
 - To release the link from the retaining bracket, hold the link and lift it upwards in its retaining slot then pull it away from the bracket.
 - To fit a new link push it into the slot of the bracket on the non-access side of the damper.
 - Rotate it upwards and secure with the release latch
- Test and check the damper by the method detailed in the 'Initial Operating Check'.
- Refit the access door and complete maintenance reports as appropriate.

Fire Damper Certificate

DW 145 Inspection & Handover Check Sheet to be completed by the installer with a separate certificate for each damper.

No.	Question	Guidelines	Tick
1	Are the dampers the correct type?	Fire Damper Model 0160, 0400MAN Fire Damper Model 2550, 2530, 26SCD and 0400FME	
2	Are the dampers correctly identified?	Identification label clearly shows the damper individual reference number	
3	Are the dampers located correctly?	The damper position matches the position as detailed on the manufactures installation instructions	
4	Have supports for both the damper and the adjacent ductwork been installed in accordance with the approved method?		
5	Are the dampers fitted in the correct orientations?	The dampers are installed the correct way up relative to airflow and access	
6	Is access, through the ductwork to the damper unobstructed?	There is unobstructed space to allow safe access to damper, also through ceiling void and adjacent services	
7	Confirm the space around the damper has not been used for the passage of other services	The presence of other services will invalidate the installation method	
8	Using the access opening provided, confirm that the damper has been left in the open position		
9	Release the damper catch to simulate the thermal release mechanism (damper drop test)	Ensure the blade operation is free from interference	
10	Check damper blades for damage	With the damper in the closed position inspect for damage	
11	Re-set damper and replace access panel	After resetting check that if supplied the visual position indicator is correct	
12	Is the fire barrier and penetration seal complete?	Confirm at handover if installation is complete and if no then other trades will be required to finish	
13	Handover damper installation for commissioning	Obtain relevant acceptance of the damper installation from the nominated person responsible	

Project	Installer Name	
Damper ID No:	Company	
Location	Date	
Type	I hereby confirm the damper detailed has been installed and tested according to the manufactures recommendations	
Model No:	Signature	